

PROGRAMME MAZOUT PROGRAMMA

**CATALYSEURS
VERGASER
PYRAMIDE EFEL**



P-M02

**BRULEUR
BRANDER**



P-M04

**CARBURATEUR
AP.**

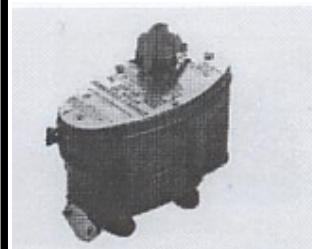

P-M07

**POMPES IMMERGEES
DOMPELPOMP**



P-M14

**FLEXIBLES
MAZOUT
DARMEN**



P-M09

**RACCORDS
KOPPELINGEN
1 x racc. droit
1 x racc. Droit union**

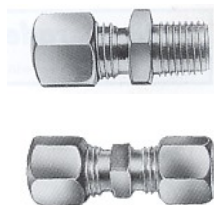

P-M15

**VANNES
KRANNEN**



P-M09

FETIMEX SA
Rue de la gare, 100
4347 Voroux-Goreux

www.fetimex.be

Tel. 04/250.18.57

Fax 04/250.32.55

M-01

CROQUIS	DESIGNATION	COND.	REFERENCE	PRIX €
ONTWERP	BESCHRIJVING	INH.	REFERENTIE	PRIJS €

Catalyseur - Vergasser					
	EFEL 6" PYRAMIDE H = 125mm	{6}	05-100337	*	
	EFEL 9" PYRAMIDE H = 170mm	{6}	05-100339	*	
	ANNEAU INOX - SUPPORT 6" D : 142 d : 95	1	05-103113	*	
	ANNEAU INOX - SUPPORT 8" D : 170 d : 105	1	05-103112	*	
	ANNEAU INOX - SUPPORT 10" D : 210 d : 118	1	05-103111	*	
	CATALYSEURS MANDARINE -MANDARIJN VERGASSER				
	EFEL 6" H : 126 - D : 105 - d : 58	1	05-032824	*	
	EFEL 8" H : 155 - D : 110 - d : 80	1	05-026428	*	
	EFEL 10" H : 155 - D : 150 - d : 80	1	05-026429	*	
	1/2 SUPPORT CATAL 6" 1/2 MIND CATAL STEUN 6"	1	05-032822	*	
	1/2 SUPPORT CATAL 8" 1/2 MIND CATAL STEUN 8"	1	05-023908	*	
	1/2 SUPPORT CATAL 10" 1/2 MIND CATAL STEUN 10"	1	05-023920	*	
		SOSDE 600/6" H : 140 - D : 85	{6}	05-102006	*
		SOSDE 800/8" H : 218 - D : 100 d : 90	{6}	05-102008	*
		SOSDE 1000/10" H : 225 - D : 130 d : 102	{6}	05-102010	*
	 	CATA 93010 - BRULEUR 10" H : 90 DOVRE - FLANDRIA VOOR BRANDER 10" D : 85	1	05-102060	*
ANNEAU INOX - SUPPORT 10"		1	05-093010	*	

CROQUIS ONTWERP	DESIGNATION BESCHRIJVING	COND. INH.	REFERENCE REFERENTIE	PRIX € PRIJS €
--------------------	-----------------------------	---------------	-------------------------	-------------------

FRANCO-BELGE



CATALYSEUR Pt - FB4 H. 90 - D 85

1

05-160190

*

CATALYSEUR Gd - FB5 H. 115 - D. 85

1

05-160192

*

CHAPEAU - FB

1

05-161191

*

ANNEAU INOX - FB D.150 - d. 110

1

05-161193

*

PEETERS * prix nets - nette prijzen



CATA TORNADO 10" Nouveau modèle
pour 305-325 / 3110-3120
H. 155 - D. 190 - d. 130

1

05-305573

*

CATA TORNADO 8" Nouveau modèle
pour 318; 319; 324; 410; 420; 3111; 3121
H. 160 - D. 147 - d. 90

1

05-318573

*



CATA TORNADO 7"
pour 303; 317;
H. 165 - D. 90 - d. 70

1

05-327573

*



CATA TORNADO 8" Ancien modèle
H. 75 - D. 147 - d. 113

1

05-324573

*

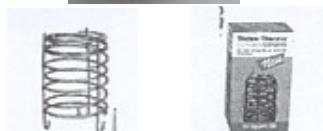

UNIVERSEL ET REGLABLE
UNIVERSEEL EN REGELBAAR
3500 W - 7500 W

05-100438

*

CROQUIS ONTWERP	DESIGNATION BESCHRIJVING	COND. INH.	REFERENCE REFERENTIE	PRIX € PRIJS €
--------------------	-----------------------------	---------------	-------------------------	-------------------

2007 BRULEURS MAZOUT - OLIE BRANDERS

	E 6" DOUBLE PAROIS D. in 145 DUBBEL WANDIG H 160	1	05-155199	*
	E 8" DOUBLE PAROIS D. in 175 DUBBEL WANDIG H 160	1	05-155201	*
	E 10" DOUBLE PAROIS D. in 210 DUBBEL WANDIG H 190	1	05-155192	*
	JOINT LYTHERM D. 270 - d. 215 BRULEUR 10" - EP 0,3	1	05-111389	*
	JOINT LYTHERM D. 215 - d. 180 BRULEUR 8" - EP 0,3	1	05-111390	*
	JOINT LYTHERM D.200 - d.151 BRULEUR 6" - EP 0,3	1	05-116306	*
	D. 140 H. 160	6"	05-033522	*
	ENSEMBLE BRULEUR SIMPLE PAROI EFEL D. 175 H. 165 ENKELWANDIG BRANDER	8"	05-033523	*
	D. 210 H. 165	10"	05-033525	*
	BS 92008 DOUBLE ENVELOPPE 8" DUBBELWANDIG D. 175 H. 190	1	05-336608	*
	BS 93010 DOUBLE ENVELOPPE 10" DUBBELWANDIG D. 210 H. 190 pour DOVRE - FLANDRIA - SAYE	1	05-336610	*
	Bruleur NU FB C4T db/p - db/w H=145 mm - D=220 mm Naaktbrander FB C4T	1	05-160090	*
	Bruleur NU FB C5T db/p - db/w H=180 mm - D=220 mm Naaktbrander FB C5T	1	05-160092	*

CROQUIS ONTWERP	DESIGNATION BESCHRIJVING	REFERENCE REFERENTIE	PRIX € PRIJS €
--------------------	-----------------------------	-------------------------	-------------------

DEVILLE - PIECES DETACHEES - MAZOUT - WISSELSTUKKEN

2005

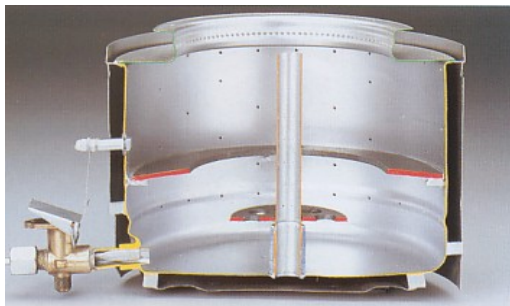

ENS. BRULEUR EQUIPE D 200 (9424)	DE-028675	*
TUBE INDUCTEUR	DE-010847	*
ANNEAU DIFFUSEUR	DE-010008	*
DEMI-ANNEAU SUPPORT	DE-009882	*
DEMI-ANNEAU	DE-009883	*
JOINT - <i>DICHTING</i>	DE-026906	*
ENS. BRULEUR D 240 (9618)	DE-012798	*
TUBE INDUCTEUR	DE-010847	*
ANNEAU DIFFUSEUR	DE-010008	*
DEMI-ANNEAU SUPPORT	DE-009884	*
DEMI-ANNEAU	DE-009885	*
JOINT - <i>DICHTING</i>	DE-027546	*
ENS. BRULEUR D 280 (9444/94) (9648)	DE-009897	*
TUBE INDUCTEUR	DE-010847	*
ANNEAU DIFFUSEUR	DE-010008	*
DEMI-ANNEAU SUPPORT	DE-009886	*
DEMI-ANNEAU	DE-009887	*
JOINT - <i>DICHTING</i>	DE-027547	*
ENS. BRULEUR D 340 (9252/53)	DE-014290	*
TUBE INDUCTEUR	DE-010848	*
ANNEAU DIFFUSEUR	DE-010008	*
DEMI-ANNEAU SUPPORT	DE-009888	*
DEMI-ANNEAU	DE-009889	*
JOINT - <i>DICHTING</i>	DE-027548	*

CROQUIS ONTWERP	DESIGNATION BESCHRIJVING	COND. INH.	REFERENCE REFERENTIE	PRIX € PRIJS €
--------------------	-----------------------------	---------------	-------------------------	-------------------

DECRASSEURS - ONTKRASSER

	LG 017 - type EMY	1	05-336017	*
	CT 021 - type 119208	1	05-336021	*
	JOINT ROND BOURRAGE FB	1	05-336000	*
	BOURRAGE H626 JOINT DECRASSEUR EFEL/M DICHTING VOOR ONTKRASSER/M	1	05-155028	*
	DECRASSEUR COMPLET BRANDERREINIGER	1	05-016149	*
	JOINT ROND GRAPHITE RONDEAFDICHTING 2mm	/M	05-156028	*
	TUBE DECRASSEUR L=52mm/26 REININGSLEIDING	1	05-034533	*
	TUBE DECRASSEUR L=150mm-55 REININGSLEIDING	1	05-034531	*

ETANCHEITE POUR DECRASSEUR - AFDICHTING VR ONTKRASSER

	LOCTITE® 5972 HIGH TEMPERATURE TUBE DE 200 ml N°18865		05-101372	*
		{12}		*

REGULATEURS DE TIRAGE - TREKREGELAARS

	DIAMETRE 127 / DIAMETER 127	1	05-150801	*
	BUSELOT 127 MUURING	1	05-150810	*
	DIAMETRE / DIAMETER 153	1	05-150803	*
	BUSELOT 153 MUURING	1	05-150811	*

CROQUIS ONTWERP	DESIGNATION BESCHRIJVING	COND. INH.	REFERENCE REFERENTIE	PRIX € PRIJS €
--------------------	-----------------------------	---------------	-------------------------	-------------------

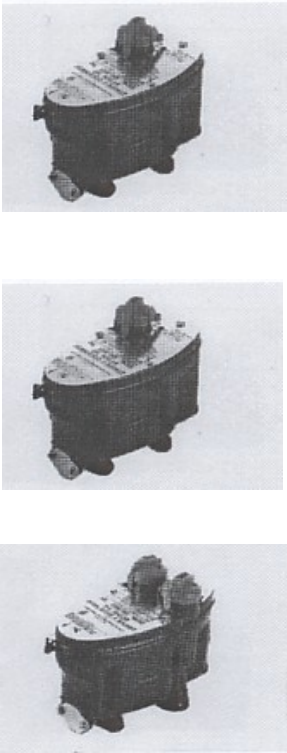

CARBURATEURS MAZOUT - MAZOUTVERGASSER - 2008

	AP 240 VR		Sortie dessous Uitgang onder				
	POUR BRULEUR VOOR BRANDER	6"	1	05-364350	*		
		8"	1	05-374350	*		
		10"	1	05-384350	*		
	AP 240 VRS		Sortie côté Zuuitgang				
	POUR BRULEUR VOOR BRANDER	6"	1	05-365300	*		
		8"	1	05-375300	*		
		10"	1	05-385300	*		
	AP 240 VRL		Double Dubbel				
	POUR BRULEUR VOOR BRANDER	8"	1	05-364200	*		
		10"	1	05-364222	*		
	AUTRES DEBITS ANDERE DEBIETEN						
	A CALIBRER SUR DEMANDE	240 VR	1	05-364351	*		
	TE REGELEN OP AANVRAAG	240 VRS	1	05-365301	*		
		240 VRL	1	05-365201	*		
AP 252 AY		Pour bateau Vr scheepvaart					
CALIBRE 8 & 10 GEREGELD	c 30/5	{6}	05-046132	*			
PETROLE / VISCOSITE 1,8							
	VRS - LATERALE 6"	1	05-360300	*			
	VRS - LATERALE 8"	1	05-370300	*			
	VRS - LATERALE 10"	1	05-380300	*			

FILTRE FILTER		JOINT ANCIEN MODELE AFDICHTING OUD MODEL		JOINT NOUVEAU MODELE AFDICHTING NIEUW MODEL	
05-365012	*	05-365000	*	05-365001	*
					

CROQUIS	DESIGNATION	COND.	REFERENCE	PRIX €
ONTWERP	BESCHRIJVING	INH.	REFERENTIE	PRIJS €

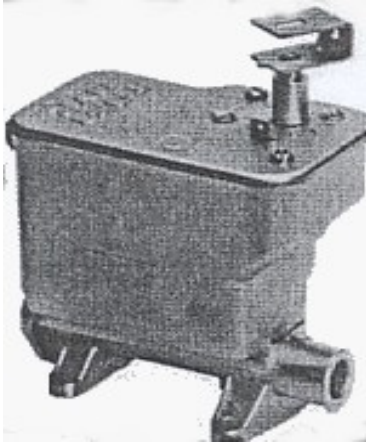
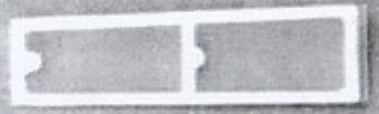
CARBURATEUR MAZOUT - OLIE NIVEAUREGELAARS

  	TOBY DVR		Sortie dessous <i>Uitgang onder</i>		
	POUR BRULEUR VOOR BRANDER	6"	1	05-367006	*
		8"	1	05-367008	*
		10"	1	05-367010	*
	TOBY DVR		Sortie côté <i>Zuuitgang</i>		
	POUR BRULEUR VOOR BRANDER	6"	1	05-367106	*
		8"	1	05-367108	*
		10"	1	05-367110	*
	FILTRE / FILTER				
	TOBY DVR	1	05-367003	*	
	JOINT / AFDICHTING				
	TOBY DVR	1	05-367002	*	

ACCESSOIRES MAZOUT - OLIE ONDERDELEN

	BICONE / KNELRING ABEX	1	05-150112	*
	ECROUS / MOEREN ABEX	1	05-151504	*
	RACCORD DROIT ABEX RECHT AANKOPPELSTUCK ABEX	1	05-152734	*
	RACCORD COUDE ABEX KNIE KOPPELING ABEX	1	05-152733	*

DEVILLE

ACCESSOIRES TOBY TN

TOEBEHOREN

	KIT DE MAINTENANCE POUR CARBURATEUR TOBY TN (Filtre-Tige de clapet-Soupape d'admiss.)	1	2005 DE-045347	prix nets *
	BILLE TOBY - Sachet de 10	1x10	DE-070200	*
	JOINTS FILTRE TOBY TN (10)	1x10	DE-341770	*

CROQUIS	DESIGNATION	COND.	REFERENCE	PRIX €
ONTWERP	BESCHRIJVING	INH.	REFERENTIE	PRIJS €

VANNES MAZOUT KRANEN 2008					
	A POINTEAU - BAGUE NYLON - NAALDKRAAN		EN-12514-2 - DIN 4736-2		
	PN 10 GOK - 02 324 05	8 X 8	10	05-350101	*
	PN 10 GOK - 02 325 05	10 X 10	10	05-350102	*
	1/4 TOUR / DRAAI - BAGUE CUIVRE		DIN 4736-2 EN-12514-2		
	PN 16 - 03 403 06	8 X 8	20	05-390308	*
	PN 16 - 03 404 06	10 X 10	20	05-390310	*
	PN 16	12 X 12	20	05-390312	*
	COLLIERS / BEUGELS				
	POUR VANNE	ø8 ø10-1/4		05-173230	*
	VOOR KRAAN	ø12 ø3/8		05-193231	*
	VANNES A BILLE PN 30 - DIN KOGELKRAAN				
	CONVIENT POUR ESSENCE, FUEL, HUILE, MAZOUT, KEROSENE KAN GEBRUIKT WORDEN VOOR BENZINE, FUEL, OLIE, KEROZENE				
F X F TAJO 2000	1/4		05-121100	*	
	3/8		05-121101	*	

FLEXIBLES MAZOUT SLANGEN					
	DROIT - RECHT				
	LG 500 MM - 8 X 8		1	05-340612	*
	LG 750 MM - 8 X 8		1	05-340613	*
	LG 500 MM - 8 X 10		1	05-340615	*
	LG 750 MM - 8 X 10		1	05-340616	*
	COUDE 90° / KNIE				
LG 500 MM - 8 X 8		1	05-340630	*	
LG 750 MM - 8 X 8		1	05-340631	*	

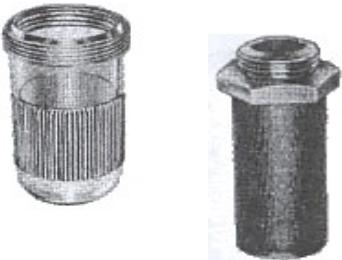

CROQUIS ONTWERP	DESIGNATION BESCHRIJVING	COND. INH.	REFERENCE REFERENTIE	PRIX € PRIJS €
--------------------	-----------------------------	---------------	-------------------------	-------------------

2008		FILTRES – GOK – FILTERS		2008	
	FILTRE SIMPLE AVEC ROBINET FILTER MET KRAAN - GOK - 13007	1	05-350202	*	
	TYPE 200 3/8 X 3/8 F X F BIN X BIN	10		*	
	FILTRE SIMPLE SANS ROBINET FILTER ZONDER KRAAN - GOK - 13015	1	05-350252	*	
	TYPE 200 3/8 X 3/8 F X F BIN X BIN	10		*	

ACCESSOIRES / ONDERDELEN					
	13 009 21	Elément filtrant Filterelement	1	05-350394	*
	13 007 27 – Type 85	Godet / Beker	1	05-350388	*
	13 009 27 – Type 200	Godet / Beker	1	05-350387	*
	13 007 23 – Type 85	O-Ring	1	05-350390	*
	25 520 28 – Type 200	O-Ring	1	05-350392	*

ACCESSOIRES CITERNES ET BRULEURS TOEBEHOREN VOOR TANK EN BRANDER						
JAUGES - INHOUDSMETERS						
	GOK UNIVERSELLE 15076 Réglable Regelbaar	0 - 2M R - 1 1/2"	1	05-315204	*	
			10		*	
	TUYAU CRISTALIN PVC DARM	8 X 12	25 M	05-516900	*	
		8 X 12	100 M		*	
		8 X 14	100 M		05-516901	*
	REDUCTION PVC REDUCTIE	R 2" - 6/4		1	05-315224	*
				10		*
		R 6/4 - 1"		1	05-315225	*
				10		*
		R 2" - 1"		1	05-315226	*
			10	*		

CROQUIS	DESIGNATION	COND.	REFERENCE	PRIX €
ONTWERP	BESCHRIJVING	INH.	REFERENTIE	PRIJS €

BOUCHON D'AERATION - VERLUCHTINGSSTOP						
	PVC	15050	5/4 F-BIN	10	05-315332	*
		15051	6/4 F-BIN	10	05-315333	*
		15052	2" F-BIN	10	05-315334	*
	LAITON		5/4 F-BIN	1	05-315432	*
	MESSING		6/4 F-BIN	1	05-315433	*
			2" F-BIN	1	05-315434	*
	BOUCHON DE REMPLISSAGE - VULSTOP					
			Laiton à cadenasser 2" F-BIN <i>In messing afsluitbaar</i>	1	05-315337	*
				10		*
		Avec capuchon vert 2"F <i>Met groen deksel</i>	1	05-315437	*	
			10		*	
			50		*	
CAPUCHON SEUL B-R-23 DEKSEL ALLEEN VOOR VULSTOP						
		VERT-GROEN			05-101301	*
		ORANGE-ORANJE			05-101302	*
		ROUGE-ROOD			05-101303	*
SIFFLET D'ALARME - ALARMFLUIT						
	1508703	GOK 5/4		1	05-315101	*
		A = R - 5/4 F		10		*
		B = R - 6/4 M		50		*
		C = R - 5/4 M				
			EURO ASR 20-R2"		1	05-315102
	RACCORD SIMPLE	PVC		1	05-315302	*
	ENKELE KOPPELING			10		*
	R- 6/4 F + RACC. NYL. - ø6-8-10-12					
	TETE DE PLONGEUR			1	05-315303	*
	DUBBELE TANKDOORVOERNIPPEL					
	PVC R-6/4 - 2 X 10/12			10		*
	MAMELON - 2"			1	04-280N84	*

POMPES DE TRANSFERT - OVERDRACHTPOMPEN
POMPE ASPIRATE - AANZUIGPOMP

BM



ECKERLE

NEW



ASPIRATION MAXIMALE
 MAX. AANZUIGHOOGSTE 8 M

DEBIT MAXIMUM
 MAX. DEBIET 20 L/H-U

RACCORDEMENT
 AANSLUITING \varnothing 6/8 MM

TYPE	REFERENCE
BM 346 - 3L	05-364346
	EURO
	1 pc/st *
	2 pcs/stk *

TYPE	REFERENCE
BM 347 - 12L	05-364347
	EURO
	*

PIECES DE RECHANGE BM	
FILTRE BM	05-364375
	EURO
	*
MICROSWITCH BM	05-364300
	EURO
	*

AGREEE CE
 NORME : EN - 12514

ASPIRATION MAXIMALE
 MAX. AANZUIGHOOGSTE 7M

RACCORDEMENT
 AANSLUITING \varnothing 6/8 MM

TYPE	REFERENCE
ECKERLE SP 32	05-364032
	EURO
	1 pc/st *
	2 pcs/stk *

Pompe aspirante automatique, avec bac de rétention et sonde de détection de fuite.
 Affichage LCD du cycle et des mises en dérangement.
Automatische aanzuigpomp, met olieopvangpak en olielekdetectie.
LCD aanduiding van cyclus en storingen.
 Débit / Debiet : max. 8 l/h (7m) - 18 l/h (4m)

PIECES DE RECHANGE ECKERLE		
BOBINAGE SP32	05-364900	*
PISTON SP32	05-364905	*
SOUPAPE ASPIRAT.	05-364906	*
FILTRE	05-364907	*

POMPE ASPIRANTE REFOULANTE / 2007 AANZUIG EN STUWPOMP

POMPE REFOULANTE POUR POËLES A MAZOUT / STUWPOMP VOOR OLIE KACHELS

ECKERLE

SK 9E
FP 8E



PAS DE CLAPET DANS LA CONDUITE
D'ASPIRATION
GEEN VOETKLEP IN DE
ASPIRATIELEIDING



Exige un détendeur / Ontspanner nodig

ASPIRATION MAX AANZUIGHOOGTE	3 M
REFOULEMENT MAX STUWVERMOGEN	15 M
DEBIT MAX DEBIET	10 L/H-U
RACCORDEMENT - AANSLUITING	ø 6-8

Pièces de rechange ECKERLE		
SK9-E	REFERENCE	EURO
Piston SK8 - SK9	05-364806	*
Soupape aspiration SK9	05-118656	*
Soupape refoulement SK9	05-118657	*
Filtre	05-001830	*
Bobine SK9-FP8	05-001804	*

TYPE	REFERENCE
SK9-E	05-364012
	EURO
	*

DETENDEUR MAZOUT / OLIEONTSPANNER 2008				
	GOK TYPE ODR PN10 (EN 12514-2) DIN 4736-2			
	PRESSION D'ENTREE INGANGDRUK	0,5-6 BAR	PRESSION DE SORTIE UITGANGDRUK	100MBAR
	8 X 8	1	05-365151	*
	10 X 10	1	05-365152	*

CROQUIS	DESIGNATION	COND.	REFERENCE	PRIX €
ONTWERP	BESCHRIJVING	INH.	REFERENTIE	PRIJS €

POMPE IMMERGE - 2007 - DOMPELPOMP						
TYPE 280 	TENSION	230 V	1	05-364280	*	
	PUISSANCE	8 W				
	DEBIT MAX A 8 M MAX DEBIET	7 L/H-U	3	05-364280	*	
	HAUTEUR MAX	8,5 M				
	ø	8 MM				
PIECE DE RECHANGE						
FILTRE OIL PRESS		1	05-101272	*		
PISTON CPLT		1	05-094432	*		
Prix, simplicité & efficacité Prijs, simpel & effcient						

Excellent rapport qualité / prix

Verhouding prijs / kwaliteit

TUBE D'ALUMINIUM ISOLE AVEC GAINE PVC 2008				
ALUMINIUM MAZOUTLEIDING MET PVC MANTEL 2008				
DIAMETRE	DESIGNATION - OMSCHRIJVING	REFERENCE	PRIX / M EURO	
			PAR ROULEAU PER ROL	PAR 500 M PER 500 M
				
ø 4 - 6	ROULEAU DE 100 M ROL VAN 100 M	05-315610	*	*
ø 6 - 8	ROULEAU DE 100 M ROL VAN 100 M	05-315611	*	*
ø 8 - 10	ROULEAU DE 50 M ROL VAN 50 M	05-305612	*	*
	ROULEAU DE 100 M ROL VAN 100 M	05-315612		
ø 10 - 12	ROULEAU DE 50 M ROL VAN 50 M	05-305613	*	*
	ROULEAU DE 100 M ROL VAN 100 M	05-315613		

RACCORDS ACIER MAZOUT - STALLEN KOPPELINGEN

TYPE	REFERENCE	PRIX - PRIJS €
------	-----------	----------------

2008



DROIT UNION
RECHTE VERBINDING

8 X 8	05-340102	*
10 X 10	05-340103	*
12 X 12	05-340104	*



REDUCTION
REDUCTIE

10 X 8	05-340113	*
12 X 8	05-340115	*
12 X 10	05-340116	*



COUDE UNION
KNIE KOPPELING

8 X 8	05-340132	*
10 X 10	05-340133	*



T. UNION
T. VERBINDING

8 X 8 X 8	05-340402	*
10 X 10 X 10	05-340403	*
12 X 12 X 12	05-340404	*



T. REDUCTION
T. REDUCTIE

10 X 10 X 8	05-340420	*
10 X 8 X 10	05-340421	*
12 X 12 X 10	05-340431	*
12 X 10 X 12	05-340430	*
12 X 8 X 12	05-340438	*

TYPE	REFERENCE	PRIX - PRIJS €
------	-----------	----------------

2008



DROIT - MALE
RECHTE BTD

M 1/4 - 8	05-340205	*
M 3/8 - 8	05-340206	*
M 1/2 - 8	05-340207	*
M 1/4 - 10	05-340208	*
M 3/8 - 10	05-340209	*
M 1/2 - 10	05-340210	*
M 1/4 - 12	05-340211	*
M 3/8 - 12	05-340212	*
M 1/2 - 12	05-340213	*



DROIT FEMELLE
RECHTE BND

F 1/4 - 8	05-340253	*
F 3/8 - 8	05-340254	*
F 1/2 - 8	05-340255	*
F 3/8 - 10	05-340257	*
F 1/2 - 10	05-340265	*
F 3/8 - 12	05-340258	*
F 1/2 - 12	05-340259	*





COUDE MALE
KNIE BTD

M 1/4 - 8	05-340354	*
M 3/8 - 8	05-340355	*
M 1/4 - 10	05-340357	*
M 3/8 - 10	05-340358	*



COUDE FEMELLE
KNIE BND

F 1/4 - 8	05-340324	*
F 3/8 - 8	05-340321	*
F 3/8 - 10	05-340327	*

CROQUIS ONTWERP	DESIGNATION BESCHRIJVING	Ø	COND. INH.	REFERENCE REFERENTIE		PRIX € PRIJS €
	NIPPLE NYLON NYLON KNELRING	8 MM	100	05-340522	%	*
		10 MM	100	05-340523	%	*
		12 MM	100	05-340524	%	*
		*10 - 8	100	05-340530	%	*
		*12 - 8	100	05-340531	%	*
		*12 - 10	100	05-340532	%	*
	BAGUE CUIVRE MESSING KNELRING	8 MM	100	05-340008		*
		10 MM	100	05-340009		*
		12 MM	100	05-340010		*
	ECROU ACIER STAL MOER	8 MM	50	05-340002		*
		10 MM	50	05-340003		*
		12 MM	50	05-340004		*
	BOUCHON ACIER STAL STOP	8 MM	50	05-340191		*
		10 MM	50	05-340192		*
		12 MM	50	05-340193		*
	BAGUE ACIER STAL KNELRING	8 MM	100	05-340023		*
		10 MM	100	05-340024		*
		12 MM	100	05-340025		*

**MECHES POUR POELES A PETROLE
WIEKEN VOOR PETROLEUMKACHEL**

PRIX NETS - NETTO PRIJZEN

MARQUES ET TYPES DE POELE MERK EN TYPE KACHEL	N°	CODE MECHE WIEKKODE	REFERENCE REFERENTIE	PRIX € PRIJS €
ACDR				
ASR - 27/33/34	16	ASR 33	05-903033	*
ALLEGRO				
E 26 - S 25.6	30	WATTFLAM	05-903030	*
CANDLE				
	26	7000	05-903700	*
CARTRIDGE				
	26	7000	05-903700	*
CORONA				
RX 170, 270	4	RX 270	05-903270	*
SX 187, SX 227, SX 270	4	RX 270		*
SX / RX 2200, 2220	4	RX 270		*
RX 2350, 2500, 2790	4	RX 270		*
SX 2350, 2400, 2790	4	RX 270		*
RX 3000, 3350, SX 3500, 3350	3	3100	05-903300	*
SX 3, SX 30	1	SX 3	05-903003	*
SX 2C, RX 160X	2	SX 2	05-903002	*
RX 250, RX 260	2	SX 2		*
COSMOS				
86 C	20	RCA 86	05-903086	*
ELEGANCE				
3400 PETCH KA	10	DSK 34	05-903034	*
2600	12	KHF 95	05-903095	*
EQUATION				
S 25	30	WATTFLAM	05-903030	*
EUROSTOVE				
LONDON, R 99 C, RCA 882, 883	20	RCA 86	05-903086	*
R 2.5 C, RCA 680	21	RCA 66 - 68	05-903066	*
R 3300 C	22	RCA 100	05-903100	*
R 55 C, R 2400 C	23	RCA 200	05-903200	*
R 30, 40	24	R 398	05-903398	*
FUJIKA				
3400 PETCHIKA	13	EVER PTE 12	05-903012	*
KSP 1, KSP 222 PET, KSP 229, KSP 231	8	JUMBO 2200	05-903220	*
FKH 5000 HUSKY	6	FKH 5000 HUSKY	05-903-500	*
KERO				
2100, 2101, 2300, 2301	4	RX 270	05-903270	*
2500, 2501, 2700, 2701	4	RX 270	05-903270	*
2900, 2901, 3000, 3001	3	3100 (Corona)	05-903300	*
3300, 3301	3	3100 (Corona)	05-903300	*
KEROSUN				
R 25, DC 60	21	RCA 66 - 68	05-903066	*
DC 80	20	RCA 86	05-903086	*
R 3000 eco	22	RCA 100	05-903100	*
KETAC (Gracia)				
KHF 100, 105, 110	12	KHF 100	05-913100	*
KOBY				
500	20	RCA 86	05-903086	*

PRIX NETS - NETTO PRIJZEN

MARQUES ET TYPES DE POELE MERK EN TYPE KACHEL	N°	CODE MECHE WIEKKODE	REFERENCE REFERENTIE	PRIX € PRIJS €
PLANA KAMIN				
R 25	21	RCA 66 - 68	05-903066	*
3300 W	22	RCA 100	05-903100	*
ROBESON				
S 95	10	S 95 (Toyokuni)	05-903034	*
SENSTONE				
SKH 192, SKH 2201	12	SKH 2201 = KHF 100	05-903095	*
SHARP				
HSR 31 F, HSR 4, HSR 48, HSR 49	10	DSK 34	05-903034	*
HSR 70, HSR 88 F, HSR 200	10	DSK 34		*
HSR 11201	10	DSK 34		*
SUPRA				
SUPRA DUOFLAM 2500	4	RX 270	05-903270	*
TAYOSAN				
T 2.5	4	RX 270	05-903270	*
T 2.5 CS	4	RX 270		*
T 3.5 CS	3	3100 (Corona)	05-903300	*
240, 260, 360	5	TKUNI 233	05-903233	*
TOSAI				
2400, 2401, 2451, 2481, 2501, 260(1)	4	RX 270	05-903270	*
TOYOKUNI				
LEOPET 341 R, TSK 80 EU, 101 EU	10	S 95 (DSK 34)	05-903034	*
TSK 81 EGS, TSK 95, TSK 608	10	S 95 (DSK 34)		*
23 U, 30 E, DSK 34 (PWE), S 95	10	S 95 (DSK 34)		*
DSK 344, DSK 335	10	S 95 (DSK 34)		*
TOYOSET				
RCA 23, RCA 26 (Radiant), R 2800 C	21	RCA 66 - 68	05-903066	*
RCA 33 (Current), RCA 37	20	RCA 86	05-903086	*
RCA 36 (B, C, cm, R)	36	RCA 36	05-903036	*
TOYOSTOVE				
RCA 23, RCA 66, RCA 68(0), RS 177	21	RCA 66 - 68	05-903066	*
RCA 33, RCA 85, 86, 87, 87, 88, KRA 85	20	RCA 86	05-903086	*
RC 276, RC 880, 882, 883	20	RCA 86		*
RCA 3000	20	RCA 86		*
RCA 91, 91, 100 tot 109, RS 277	22	RCA 100	05-903100	*
RC 296 PC, RCA 1001, RCA 1080	22	RCA 100		*
WATTFIRE				
C 10	10	S 95 (DSK 34)	05-903034	*
WATTSTAR				
WATTSTAR 26 G	10	S 95 (DSK 34)	05-903034	*
ZIBRO KAMIN				
R 44 C, RCA 66, 68(0)	21	RCA 66 - 68	05-903066	*
R 545, R 22 C, R 210 C, R 510 C, R 545 C	21	RCA 66 - 68		*
R 610 C, R 845 C, R 889 C	20	RCA 86	05-903086	*
KRA 85, RCA 86(A, B, C, E), R 111 C	20	RCA 86		*
R 99 (C), RS 145 E, RCA 3000	20	RCA 86		*
RCA 100 (E), R 140 C	22	RCA 100	05-903100	*

ACCESSOIRES - ONDERDELEN**PRIX NETS - NETTO PRIJZEN**

DESIGNATION / <i>BESCHRIJVING</i>	REFERENCE / <i>REFERENTIE</i>	PRIX € / <i>PRIJS €</i>
POMPE A MAIN - <i>HANDPOMP</i>		
1	05-903301	*
12		*
60		*
POMPE ELECTRIQUE - <i>ELEKTRISCHE POMP</i>		
1	05-903000	*
6		*
RESISTANCES		
STANDARD (1)	05-903201	*
STANDARD (10)		*
INVERSEE / <i>OMGEKEERDE</i>	05-903202	*
FILTRES - <i>FILTER</i>		
TOSAÏ / CORONA	05-903601	*
ZIBRO - B - Ht 45 / TOYOSET	05-903605	*
ZIBRO A (HT 55)	05-903607	*
BOUCHONS - <i>STOP</i>		
BOUCHON ZIBRO A - TANKDOP	05-903613	*
BOUCHON RESERVOIR FIXE JAUNE	05-903617	*
BOUCHON ZIBRO "B" - TANKDOP	05-903615	*

ADDITIF ORGANIQUE POUR COMBUSTIBLES ORGANISCH ADDITIEF VOOR BRANDSTOFFEN

ADERCO 5000

2008

LA SOLUTION AUX PROBLEMES

- * Boues dans les réservoirs
- * Combustible contaminé par l'eau
- * Stratification du combustible
- * Colmatage de filtres
- * Pompe à combustible encrassée
- * Formation de carbone sur le brûleur
- * Problème de combustion
- * Suie
- * Fumée

L'additif ADERCO 5000 est un agent 100% organique, détergent, autodispersant, sans cendre, non métallique, sans solvant, non toxique et non dangereux.

ADERCO 5000 n'a qu'une action physique sur le combustible.

L'action de l'ADERCO 5000 est de briser toutes les agglomérations en particules très petites en les maintenant en suspension et de les disperser de manière homogène dans tout le combustible. ADERCO 5000 est un agent tensio-actif puissant qui augmente la vaporisation du combustible et crée une surface plus élevée en multipliant le nombre de gouttelettes formées à la tuyère du brûleur ainsi le combustible traité brûle plus complètement et réduit la formation de carbone et d'imbrûlés.

DOSAGE : 1 litre par 5000 litres de combustibles.

DE OPLOSSING VOOR PROBLEMEN ALS



- * *Bezinksel in het reservoir*
- * *Verontreiniging van de brandstof door water*
- * *Stratificatie van de brandstof door water*
- * *Verstopping van de filters*
- * *Vervuiling van de verbrandingspomp*
- * *Koolstofvorming van de brander*
- * *Problemen bij de verbranding*
- * *Roet*
- * *Rook*

ADERCO 5000 is een niet metalen, 100% organisch additief, een asvrij zuiveringsmiddel, auto-dispergerend, zonder oplosmiddel, niet giftig, noch gevaarlijk.

ADERCO 5000 heeft slechts een fysische werking op de brandstof.

Het additief ADERCO 5000 breekt alle samenklontelingen in kleine deeltjes, houdt deze in suspensie en verspreidt ze gelijkmatig over de brandstof. ADERCO 5000 is een krachtiging, aan de oppervlakte werkzaam produkt dat de verdamping verbetert en een groter verbrandingsoppervlak creeërt door het aantal druppeltjes aan het pijpje van de brander te vermenigvuldigen. De brandstof ondergaat een vollediger verbranding en vermindert de vorming van koolstof en onverbrande brandstof.

DOSERING : 1 liter per 5000 liter brandstof.

		Q	REFERENCE REFERENTIE	PRIX € PRIJS €	
500 ml 15 bouteilles par carton 15 flessen per doos			500 ml	1	*
				15	*
1 L EMBALLAGE : 12 bouteilles par carton VERPAKKING : 12 flessen per doos			1 L	1	*
				12	*

POUR LE CHAUFFAGE - VOOR VERWAARMING

CROQUIS ONTWERP	DESIGNATION BESCHRIJVING	COND. INH.	REFERENCE REFERENTIE	PRIX € PRIJS €
--------------------	-----------------------------	---------------	-------------------------	-------------------





ACCESSOIRES CITERNES – 2008 - ONDERDELEN VOOR TANK

JAUGES - INHOUDSMETERS				
	GOK UNIVERSELLE 15 076 <i>Réglable / Regelbaar</i> 0 - 2M R - 1 1/2"	1	05-315204	*
	10	*		
	GOK 15 078 PNEUMATIQUE <i>PNEUMATISCH</i>	1	05-315221	*
	6	*		
	SET DE MONTAGE 15 078-99 JAUGE PNEUMATIQUE	1	05-315220	*
	GOK POT DE CONDENSATION <i>CONDENSATIEPOTJE</i>	1	05-315203	*
	UNITOP Dist. Max. 50m	< 6	05-315219	*
	6	*		
	TUBE NYLON ,,,,,, 4/6 <i>BUIS</i> Rouleau de 100m <i>Rol van 100m</i>	100	05-516500	*
	300	*		
	REDUCTION <i>REDUCTIE PVC</i>	1	05-315224	*
	R 2" - 6/4 10	*		
1	05-315225	*		
R 6/4 - 1" 10		*		
1	05-315226	*		
R 2" - 1" 10		*		



CROQUIS ONTWERP	DESIGNATION BESCHRIJVING	COND. INH.	REFERENCE REFERENTIE	PRIX € PRIJS €
--------------------	-----------------------------	---------------	-------------------------	-------------------

FILTRES A MAZOUT – 2008 - OLIEFILTERS				
	FILTRE MONOTUBE GS2000 avec purge automatique via le gicleur 13.513 <i>EENPIJPSFILTER met automatis. ontluchting via sproeier</i>	1	05-350200	*
	PRESSION / DRUK PN6 RACC / AANSLUITING 3/8	5		*
	FILTRE DOUBLE 13851 06 ME <i>DUBBELFILTER</i>	1	05-350301	*
	TYPE – 500 PN6 R. 8 - 10 - 12 MM 3/8 M - Bu x 3/8 F - Bi	10		*
	FILTRE A RECYCLAGE 13861 06 <i>FILTER MET TERUGAANZUIGING</i>	1	05-350310	*
	Type – 500 PN6 ME R. 8 - 10 - 12 MM 3/8 M x F	10		*
ACCESSOIRES TYPE 500		ONDERDELEN		
	13 850 21 ELEMENT FILTRANT TAMIS INOX <i>FILTRELEMENT ZEEF INOX</i>	1	05-350395	*
	100my	10		*
	13 851 29 70my TAMIS FEUTRE <i>VERVANGINGSPATROON VILT</i>	1	05-350396	*
		25		*
	13 850 22 GODET DE FILTRE / <i>FILTER POT</i>	1	05-350389	*
	13 850 24 O-RING 500	1	05-350391	*
		10		*

CROQUIS	DESIGNATION	LG	COND.	REFERENCE	PRIX €
ONTWERP	BESCHRIJVING	LG	INH.	REFERENTIE	PRIJS €

PLONGEUR POUR CITERNE - OLIEAANZUIGSTEL					
	VANNE POLICE 1"	2150MM	1	05-315310	*
	COMBINE D'ASPIRATION & RETOUR + PRISE JAUGE, LIVRE AVEC SACHET RACCORDS EN NYLON AANZUIG + TERUGSLAG + AANSLUITING VOOR INHOUDSMETER MET KOPELINGEN NYLON		15		*
			35		*
CLAPET DE PIED - TERUGSLAGKLEP					
	PVC BLANC 3/8 F - BIN		1	05-315351	*
			25		*
	LAITON 3/8 F - BIN		1 / 25	05-315352	*
	MESSING 1/2 F - BIN		1 / 25	05-315353	*
SONDES DE SECURITE DE REMPLISSAGE - 2008					
   	LIMITEUR DE REMPLISSAGE R - 1" M-Btd BELGIQUE TANKVULBEGRENZER	*PRIX NETS / NETTO PRIJZEN			
	SONDE* VOELER	400MM	1	05-008040	*
			10		*
	SONDE* VOELER	700MM	1	05-008041	*
			10		*
	SONDE* VOELER	1000MM	1	05-008042	*
			10		*
	AVEC CÂBLE DE 1,50M* MET KABEL VAN 1,50M		1	05-150800	*
			10		*
	AVEC CÂBLE DE 5M* MET KABEL VAN 5M		1	05-150808	*
		10	*		
APPAREIL DE TEST PR SONDE* TESTTOETSEL VOOR VOELER 15098		1	05-150099	*	

CROQUIS ONTWERP	DESIGNATION BESCHRIJVING	REFERENCE REFERENTIE	PRIX € PRIJS €
--------------------	-----------------------------	-------------------------	-------------------

FLEXIBLES MAZOUT / OLIESLANGEN				
	3/8 F - F	750 MM	05-340661	*
		1000MM	05-340662	*
	3/8 F - 1/4 NPTF	750 MM	05-340603	*
		1000MM	05-340604	*
	3/8 F - 1/8 NPTF	750 MM	05-340641	*
		1000MM	05-340642	*
AUTRES LONGUEURS, DIMENSIONS ET RACCORDS SUR SIMPLE DEMANDE				

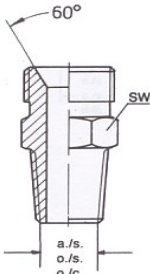
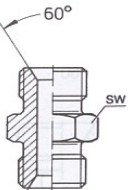
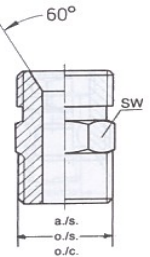
RACCORDS PR FLEXIBLES - VERBINDINGEN VR SLANGEN				
	MAMELON / NIPPELS	G 1/8 - NPTF 1/8 -- SW14	05-341001	*
		G 3/8 - NPTF 1/8 -- SW 17	05-341007	*
		G 3/8 - NPTF 1/4 -- SW 17	05-341008	*
		G 3/8 - NPTF 3/8 -- SW 17	05-341009	*
	MAMELON DOUBLE CÔNIQUE DUBBELE CONISCHE NIPPEL	3/8 - 3/8	05-341310	*
	MAMELON / NIPPELS	R 3/8 C 60° x R 1/8	05-341117	*
		R 3/8 C 60° x R 1/4 SW17	05-341118	*
		R 3/8 C 60° x R 3/8 SW22	05-341119	*
		R 1/4 C 60° x R 1/4 SW19	05-341111	*

CROQUIS	DESIGNATION	LG	REFERENCE	PRIX €
ONTWERP	BESCHRIJVING	MM	REFERENTIE	PRIJS €

FLEXIBLES POUR BRULEURS - SLANGEN BRANDERS				
	VIESMANN - UNIT WEISHAAPT WL 2, L5, L8 3/8 F d8 x 1 - 45° F8LL	750	05-340700	*
		1000	05-340701	*
	WEISHAAPT WL 10, 20 3/8 F d6 x 1 - 75° F6LL	750	05-340702	*
		1000	05-340703	*
	ABIG (M³) ABACO 3/8 F R. BANJO R4-10	1200	05-340712	*
	ELCO (JUN) 3/8 F d6 x 1 - 90° F6LL	750	05-340730	*
		1000	05-340731	*
	HOFAMAT - NORDWEST 3/8 F R. G 1/4 CSP 17	1000	05-340747	*
	CUENOD - OECHSLER BROTJE - KLÖCKNER (KL4) 3/8 F -/- 8 x 1 - 78° F 8 L	1000	05-340751	*
	RIELLO (MAINFLAMME) NW 4 3/8 F -/- 6 x 1 - 90° EC G 1/4	750	05-340760	*
		1000	05-340761	*
	RIELLO MECTRON RIELLO 40 3/8 F -/- 6 x 1 - 90° RACC. G 1/4	750	05-340762	*
		1000	05-340763	*
	THYSSEN - INTERCLIMA HANSA - GOLLING - INTERCAL 3/8 F -/- d 6 x 1 - 90° EC G 1/4	1000	05-340771	*
	OERTLI (OE9) NW 6 3/8 F -/- d 6 x 1 - 90° Ec G 1/4	750	05-340780	*
		1000	05-340781	*
	GIERSCH NW4 3/8 F - 6 x 1 - 105° F6LL	1200	05-340792	*
	GIERSCH NW4 3/8 F - RACCORD BANJO R. 8/4-14	1200	05-340796	*
	HOFAMAT - KLOCKNER (KL20) NW4 3/8 F - 6 x 1 - 90° - M 12 x 1,5	1000	05-340802	*
	ELCO NW8 - 3/8 F -/- R.G 1/8 CSP 14	750	05-340820	*

GICLEURS - SPROEIJERS

100% INOX

100% TESTE

100% GARANTI

HAGO

TABLEAU DE COMPARAISON VERGELIJKINGSTABEL

HAGO	DELAN	MONARCH	DANFOSS	STEINEN
H Cône creux .40 - 9.0 Capuchons rouges	A .40 - 8.50	NS .50 - 2.0 PL 2.25 - 8.5	H .40 - 3.00	H .40 - 2.25 PH 2.50 - 8.5
S-S Cône semi plein .40 - 35.00 Capuchons bleus	W 4.00 - 8.0	AR .50 - 2.00	B .60 - 35.00	Q .50 - 3.00 SS 4.50 - 28.0
B Cône plein .40 - 2.0 Capuchons noirs	B .40 - 2.00	R .40 - 2.00	S .60 - 2.00	S .40 - 2.00
P Cône plein 2.0 - 35.0 Capuchons verts	B 2.00 - 35.0	PLP 2.25 - 35.0	S .40 - 3.00	S 2.00 - 4.00
LC Grande capacité 35.0 - 100 Capuchons bleus	A 35.0 - 50.0 B 35.0 - 50.0	PLP 35.0 - 100.0	—	—

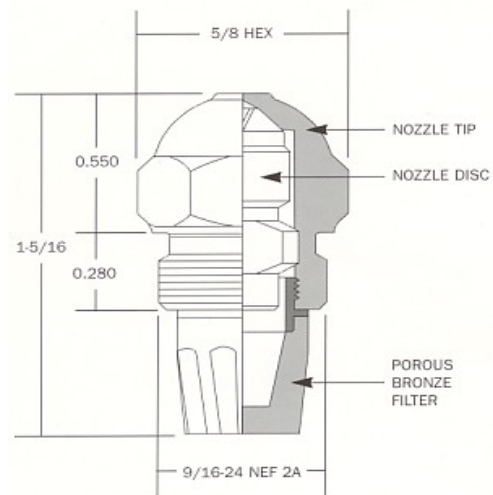

GICLEUR STANDARD - STANDAARD SPROEIJER			
			prix nets
De 0.50 à 5.50 G. US	45° - 60°	1	*
		12	*
		60	*



TYPE		PRIX NET/NETTO PRIJS		
		1	12	60
SF 0,30 0,35 GPH	45°, 60°, 80° Cône plein / Volle kegel Met secondaire filter - Avec filtre secondaire	7,95 €	7,41 €	*
SF&HF 0,40 0,45 GPH	45°, 60°, 80° Cône plein / Volle kegel Met secondaire filter - Avec filtre secondaire	7,30 €	6,81 €	*
SF&HF 0,50 1,00 GPH	45°, 60°, 80° Cône plein / Volle kegel Met secondaire filter - Avec filtre secondaire	6,48 €	6,04 €	*
S&H 1,10 15 GPH	45°, 60°, 80°	6,48 €	6,04 €	*



EAU - WATER

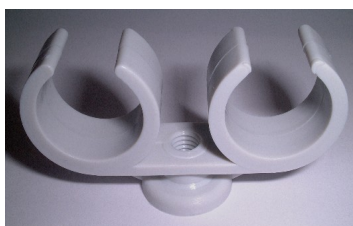

Tel. 04/250.18.57

www.fetimex.be

Fax 04/250.32.55

info@fetimex.be

RACCORDS BICONE LAITON - KNELKOPPELINGEN MESSING



RACCORD DROIT UNION RECHTE VERBINDING	REFERENCE	PRIX UNIT.
8 X 8	04-100250	*
10 X 10	04-100251	*
12 X 12	04-100252	*
15 X 15	04-100253	*



MANCHON REDUIT SOK VERLOOP	REFERENCE	PRIX UNIT.
10 X 8	04-100280	*
12 X 10	04-100282	*
15 X 10	04-100283	*
15 X 12	04-100284	*



COUDE UNION KNIKOPPELING	REFERENCE	PRIX UNIT.
8 X 8	04-100400	*
10 X 10	04-100401	*
12 X 12	04-100402	*
15 X 15	04-100403	*



TE UNION TE KOPPELING	REFERENCE	PRIX UNIT.
8 X 8 X 8	04-100300	*
10 X 10 X 10	04-100301	*
12 X 12 X 12	04-100302	*
15 X 15 X 15	04-100303	*



RACCORD DROIT MALE RECHTE BUITENDRAAD	REFERENCE	PRIX UNIT.
1/4 X 8	04-100101	*
1/4 X 10	04-100102	*
1/4 X 12	04-100103	*
1/4 X 15	04-100104	*
3/8 X 8	04-100111	*
3/8 X 10	04-100112	*
3/8 X 12	04-100113	*
3/8 X 15	04-100114	*
1/2 X 10	04-100122	*
1/2 X 12	04-100123	*
1/2 X 15	04-100124	*



RACCORD DROIT FEMELLE RECHTE BINNENDRAAD	REFERENCE	PRIX UNIT.
1/4 X 8	04-100201	*
1/4 X 10	04-100202	*
1/4 X 12	04-100203	*
1/4 X 15	04-100204	*
3/8 X 8	04-100211	*
3/8 X 10	04-100212	*
3/8 X 12	04-100213	*
3/8 X 15	04-100214	*
1/2 X 10	04-100222	*
1/2 X 12	04-100223	*
1/2 X 15	04-100224	*



RACCORD COUDE MALE BOCHT BUITENDRAAD	REFERENCE	PRIX UNIT.
3/8 X 10	04-100415	*
3/8 X 12	04-100416	*
3/8 X 15	04-100417	*
1/2 X 10	04-100419	*
1/2 X 12	04-100420	*
1/2 X 15	04-100421	*



RACCORD COUDE FEMELLE BOCHT BINNENDRAAD	REFERENCE	PRIX UNIT.
3/8 X 10	04-100445	*
3/8 X 12	04-100446	*
3/8 X 15	04-100447	*
1/2 X 10	04-100449	*
1/2 X 12	04-100450	*
1/2 X 15	04-100451	*

RACCORDS FILLETES LAITON - MESSING DRAADFITTINGEN



MAMELON M-M NIPPEL	REFERENCE	PRIX UNIT.
1/4	04-104200	*
3/8	04-104201	*
1/2	04-104202	*
3/4	04-104203	*
4/4	04-104204	*



COUDE F-F Knie bi-bi	REFERENCE	PRIX UNIT.
1/4	04-105311	*
3/8	04-105312	*
1/2	04-105313	*
3/4	04-105314	*
4/4	04-105315	*



MAMELON REDUIT VERLOOPNIPPEL	REFERENCE	PRIX UNIT.
3/8 - 1/4	04-105200	*
1/2 - 1/4	04-105201	*
1/2 - 3/8	04-105202	*
3/4 - 3/8	04-105204	*
3/4 - 1/2	04-105205	*
1" - 1/2	04-105206	*
1" - 3/4	04-105207	*



COUDE M-F KNIE bu-bi	REFERENCE	PRIX UNIT.
1/4	04-105321	*
3/8	04-105322	*
1/2	04-105323	*
3/4	04-105324	*
4/4	04-105325	*



REDUC-HEXAG 241 VERLOOPSTUK	REFERENCE	PRIX UNIT.
3/8 - 1/4	04-105210	*
1/2 - 1/4	04-105211	*
1/2 - 3/8	04-105212	*
3/4 - 3/8	04-105214	*
3/4 - 1/2	04-105215	*
1" - 1/2	04-105219	*
1" - 3/4	04-105220	*



TE F-F-F T-STUCK	REFERENCE	PRIX UNIT.
1/4	04-105331	*
3/8	04-105332	*
1/2	04-105333	*
3/4	04-105334	*
4/4	04-105335	*





RACCORD UNION F-F SCHROEFKOPPELING	REFERENCE	PRIX UNIT.
1/2	04-105012	*
3/4	04-105034	*
1"	04-105044	*



MANCHON F-F SOK bi-bi 270	REFERENCE	PRIX UNIT.
1/4	04-105301	*
3/8	04-105302	*
1/2	04-105303	*
3/4	04-105304	*
4/4	04-105305	*





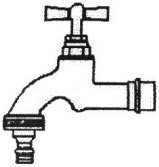

CROQUIS ONTWERP	DESIGNATION BESCHRIJVING	REFERENCE REFERENTIE	PRIX € PRIJS €
--------------------	-----------------------------	-------------------------	-------------------

ROBINETS A BILLE - KOGELKRANEN

	<p>TURIA 3000 PN 25</p> <p>F X F - MANETTE DROITE Bnd X Bnd - RECHTE HANDGREEP</p>		
	<p>3/8 (25) 04-405039 *</p> <p>1/2 (25) 04-405040 *</p> <p>3/4 (20) 04-405041 *</p> <p>1" (12) 04-405042 *</p>		
	<p>M X F - MANETTE DROITE Btd X Bnd - RECHTE HANDGREEP</p> <p>1/4 (25) 04-405350 *</p> <p>3/8 (25) 04-405351 *</p> <p>1/2 (25) 04-405352 *</p> <p>3/4 (20) 04-405353 *</p> <p>1" (12) 04-405354 *</p>		
	<p><u>ROBINET DOUBLE SERVICE - CHROME</u> <u>DUBBELE DIENSTKRAAN - VERCHROOMD</u></p> <p>1/2 - R 3/4 - 15 (15/60) 04-177413 *</p> <p>3/4 - R 3/4 - 22 (10/40) 04-177403 *</p>		

ROBINETS D'ARRET - AFSLUITKRAAN

	<p>LOURD CHROMAT 1/2 racc-rapide ZWAAR CHROMAT 1/2</p>	04-137012	*
---	--	-----------	---

COLLIER PGL SIMPLE M6 ENKEL BEUGEL PGL - M6	DIMENSION AFMERKING	EMB. VERP.	REFERENCE REFERENTIE	P. U. €
	6 mm	100	05-370100	*
	8 mm	100	05-370101	*
	10 mm	100	05-370102	*
	12 mm	100	05-370103	*
	15 mm	100	05-370104	*
	18 mm	100	05-370105	*
	22 mm	100	05-370106	*
	28 mm	100	05-370108	*
COLLIER PGL DOUBLE M6 DUBBELE BEUGEL PGL - M6	DIMENSION AFMERKING	EMB. VERP.	REFERENCE REFERENTIE	P. U. €
	2 X 8	100	05-370110	*
	2 X 10	100	05-370111	*
	2 X 12	50	05-370112	*
	2 X 15	50	05-370113	*
	2 X 18	50	05-370114	*
	2 X 22	25	05-370115	*
	GOUJON M6 DRAADNAGEL M6	DIMENSION AFMERKING	EMB. VERP.	REFERENCE REFERENTIE
	18 mm	100	05-370001	*
	25 mm	100	05-370002	*
	30 mm	100	05-370003	*
	40 mm	100	05-370004	*
			1	05-370000
CHEVILLE - CLOU (COMBI) M6 - M7 NAGELPLUG M6 - M7	DIMENSION AFMERKING	EMB. VERP.	REFERENCE REFERENTIE	P. U. €
	M6 40 mm	100	05-503640	*
	M7 40 mm	100	05-503740	*
DOCKS A VISSER M7 / 100 VIJS DOOKEN M7 / 100	DIMENSION AFMERKING	EMB. VERP.	REFERENCE REFERENTIE	P. U. €
	40 mm	100	05-370021	*
	70 mm	50	05-370024	*
COLLIER LAITON M7 /100 HESSING BEUGEL M7 /100	DIMENSION AFMERKING	EMB. VERP.	REFERENCE REFERENTIE	P. U. €
	8 mm	10/100	05-370500	*
	10 mm	10/100	05-370501	*
	12 mm	10/100	05-370502	*
	15 mm	10/100	05-370503	*
	18 mm	10/100	05-370505	*
	22 mm	10/100	05-370507	*

* Chevilles nylon également disponibles - Nylon plugen ook beschikbaar

TUYAUTERIES - BUIZEN

TUBES SANITAIRES EN CUIVRE

Usage Sanitaire et Chauffage

SANITAIRE BUIS IN KOPER

CUIVRE NU

"SANCO"

NAAKT KOPER

PLUMBING LG 5 M*	RECUIT RL 50 M	DIMENSION	POIDS / GEWICHT	PRIX
REFERENCE	REFERENCE		(KG/M)	PRIJS

* FRANCO = 1000 M				
	05-315620	8 X 1	0,196	*
	05-315621	10 X 1	0,252	*
05-317622	05-315622	12 X 1	0,307	*
05-317623	05-315623	15 X 1	0,391	*
05-317624	05-315624	18 X 1	0,475	*
05-317625		22 X 1	0,587	*

WIKU

Recuit Plastifié – Met PVC – Ribmantel

CONDITIONNEMENT	REFERENCE	DIMENSION	POIDS / GEWICHT	PRIX
			(KG/M)	PRIJS

ROULEAUX DE 25 M OU 50 M	05-316620	8 X 1	0,196	*
	05-316621	10 X 1	0,252	*
	05-316622	12 X 1	0,307	*
ROLLEN VAN 25 M OF 50 M	05-316623	15 X 1	0,391	*
	05-316624	18 X 1	0,475	*
	05-316625	22 X 1	0,587	*